



Switch Systems
Made of Porcelain, Bakelite[®]
and white Glass

Catalogue 2025

New products:



Switch system porcelain black (page 8)



Configurable junction boxes (page 29)



Overview of our switch systems.

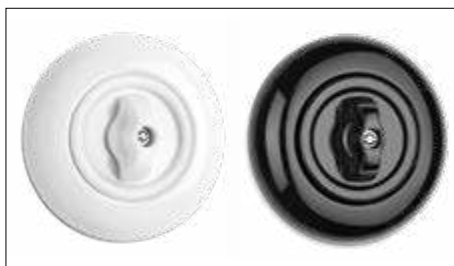

Porcelain white

Porcelain black

Page 4



Bakelite® black

Duroplast white

Page 12



White glass with Bakelite® black

White glass with Duroplast white

Page 20



Surface-mounted Bakelite® black

Surface-mounted Duroplast white

Page 24



Moisture-proof Bakelite® black

Page 26



Accessories

Page 28



Special applications

Page 29



Bells

Page 30

Classic materials, timeless shapes – new originals.
Our switch systems made of Porcelain, Bakelite® and Glass.



With their elegant design and abundant use of materials, our switch systems refer back to a time when the shape of an object was still largely determined by its function and when durability was not an "USP", but a matter of course. Material thicknesses of up to 13 mm, a base body made of steatite and durable switching mechanisms, some of which have been patented since the beginning of the 20th century, make our switches stand out from the flood of "vintage" and "retro" fakes. They are new originals, developed by us and manufactured by long-standing partners in Germany and Poland. We favour materials that have proven themselves since the beginning of electrification and still have a number of important advantages today: Porcelain, Bakelite®, Duroplast and glass. They safely insulate high voltages, are heat-resistant, do not yellow and are easy to clean with standard household cleaning agents.



Patent certificate of our German production partner from 1910.





Outlet porcelain white with single covering
Villa Fanni in Reichertshausen, Germany
More images available at www.thpg.com/en/references

1. System: Porcelain. Gleaming white and indestructible.

Hardly any other material has such a long tradition in electrical engineering as porcelain. As early as 1882, the world's first public power station in New York was fitted with rotary switches made of this finest class of ceramics. The reason for this was not the aesthetic but the functional advantages of the material: porcelain is dielectric and tracking resistant, resistant to ageing and extraordinarily hard. It is produced by sintering and smooth firing at temperatures of up to 1700 °C and is correspondingly heat and fire resistant. We use high-quality quartz porcelain (C 110), which fulfils the standard for material properties in accordance with DIN VDE 0334, Part 3. It is processed by a German manufacturer of technical porcelain with a factory in Poland to produce the long-lasting switches of this system exclusively for us.



Switch system Porcelain white.



Switch system Porcelain white



Rotary switch

10 A, 10 AX, AC 250 V. Porcelain central insert and handle. With spring mechanism.

Rotary switch alternation

Product code **186880**

Rotary switch cross

Product code **186881**

Rotary switch series

Product code **186879**

Rotary switch blind

Product code **186894**

Rotary switch two-pole

Product code **100376**



Toggle switch

10 A, 10 AX, AC 250 V. Porcelain central insert and duroplast toggle.

Toggle switch alternation

Product code **173116**

Toggle switch cross

Product code **173117**

Rocker switch

10 A, 10 AX, AC 250 V. Porcelain central insert and duroplast rocker.

Rocker switch alternation

Product code **173073**

Rocker switch cross

Product code **173074**

Rocker switch control

with glow lamp Product code **173075**



Rocker button

10 A, AC 250 V. Porcelain central insert and duroplast rocker.

Rocker button

Product code **173076**

Rocker button luminescent

Product code **100977**



Rocker button light

10 A, AC 250 V. Porcelain central insert and duroplast rocker with engraved light bulb symbol.

Rocker button light

Product code **173077**

Rocker button light luminescent

Product code **100978**

Glow lamp

The glow lamp is to be put in place of the lower screw.

Product code **173066**



Rocker button bell

10 A, AC 250 V. Porcelain central insert and duroplast rocker with engraved bell symbol.

Rocker button bell

Product code **173078**

Rocker button bell luminescent

Product code **100979**



Rocker button door opener

10 A, AC 250 V. Porcelain central insert and duroplast rocker with engraved key symbol.

Rocker button door opener

Product code **173079**

Rocker button door opener luminescent

Product code **100980**



Dimmer

AC 230 V, 50 Hz. Porcelain central insert and dimming knob.

Dimmer LED

3-35 W, 7-110 W/VA. Pressure alternation. Product code **100270**

Universal dimmer LED

3-80 W, 7-200 W/VA. Pressure alternation. Product code **100408**

Universal dimmer PRO LED

3-130 W, 7-350 W/VA. Pressure alternation. Product code **100407**



Temperature Control

230 V~/50 Hz. Use as room or floor thermostat. Duroplast central insert.

Product code **100416**

Clock Thermostat

230 V~/50 Hz. Use as a room or floor thermostat with an extended range of functions. Settings can be changed via a mini USB connection. Central insert made of Duroplast.

Product code **100415**

Remote sensor

For temperature control and clock thermostat. NTC remote sensor. Length 4 m. Length can be customized. Product code **100425**

Cover for sensor

Copper cover for our remote sensor. For installation in the floor. Ø 21 mm/8 mm, length 113 mm. Product code **100426**



Outlet

16 A, AC 250 V. Duroplast central insert. With screw contacts.

Product code **173067**

Outlet with shutter

16 A, AC 250 V. Duroplast central insert with shutter. With screw contacts.

Product code **173068**



Outlet French version

16 A, AC 250 V. Duroplast central insert. With screw contacts.

French version. With shutter. Product code **175835**

Outlet Swiss version Type 13

10 A, AC 250 V. Duroplast central insert. With screw contacts. For installation in DIN 49073-certified units. Product code **100873**



USB Charging Station

100-240 V~/50-60 Hz. Duroplast central insert. Max. charging 2,5 A in total. Two charging sockets USB Type A. Product code **181979**



Data outlet

Duroplast central insert. For 2 network adapters RJ45 (real.Cat.6a).

Product code **181978**

Note: We recommend concealed sockets with increased socket volume for easy data outlet installation.

Telephone jack

Duroplast central insert. TAE 3 x 6 NFN. For 1 telephone and 2 additional devices or data terminals. 3 x 6-pin, 6 screw contacts. Product code **150117**



Antenna outlet cable

Duroplast central insert. HF-resistant metal housing. BZT-approved. Radio and television adapter for systems with amplifiers or cable. Passage and terminal box. Product code **150121**

Antenna outlet satellite

Duroplast central insert. HF-resistant metal housing. BZT-approved. Radio and television adapter for systems with amplifiers. Compliant with DIN 45330 with additional satellite outlet. Product code **154911**



Speaker wall socket WBT

Duroplast central insert. Gold-plated connections from WBT.

Product code **100741**

Blind cover Porcelain

Duroplast central insert. Product code **181980**



Junction boxes Keystones

Central insert made of Duroplast. Technical information on the specific products can be found on our homepage. Further configurations possible, see p. 29.

SAT/Data outlet combined

Product code **181990**

Cinch connection red/white

Product code **181981**

Cinch connection yellow/black

Product code **181982**

USB-C 3.1. connection

Product code **181984**

HDMI connection

Product code **181985**

FO socket Simplex

Product code **181988**

FO socket Duplex

Product code **181989**

Universal cable outlet

Product code **181986**



Single covering

Ø 82 mm. Suitable for all switches, dimmers and outlets of the THPG switch system Porcelain.
Product code **173085**



System covering external

Ø 82 mm. For vertical or horizontal assembly. Suitable for all switches, dimmers and outlets of the THPG switch system Porcelain.
Product code **173088**



System covering centre

Ø 82 mm. For vertical or horizontal assembly. Suitable for all switches, dimmers and outlets of the THPG switch system Porcelain.
Product code **173087**



Double covering

External dimensions 82 x 153 mm. For vertical or horizontal assembly. Suitable for all switches, dimmers and outlets of the THPG switch system Porcelain.
Product code **173090**

Single covering for junction boxes

Ø 82 mm. Suitable for junction boxes, temperature controls, clock thermostat and USB charging station of the THPG switch system Porcelain.
Product code **173086**

System covering for junction boxes external

Ø 82 mm. Suitable for junction boxes, temperature controls, clock thermostat and USB charging station of the THPG switch system Porcelain.
Product code **173089**

Dimensions and assembly (in mm)

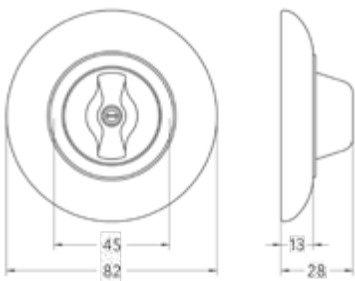

Single covering with rotary switch

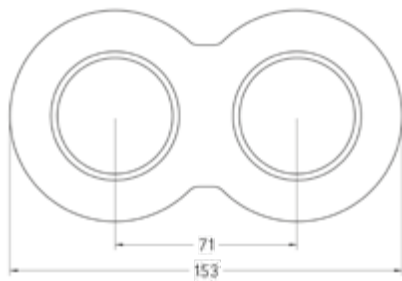

Double covering

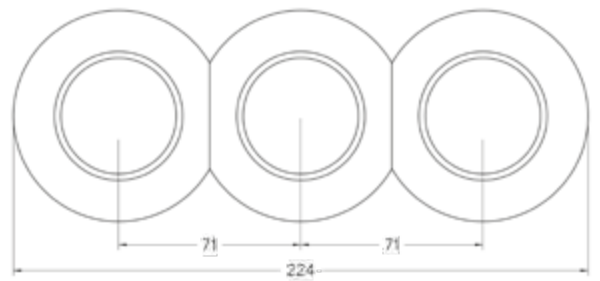

System covering with three covers

Assembly note: The spacing of the inserts in all multiple and system coverings correspond to the standard spacing of 71 mm and can be used in existing installations without any problems. The porcelain switch system of course fits into the commercially available, standardised flush-mounted boxes (e.g. from Kaiser).

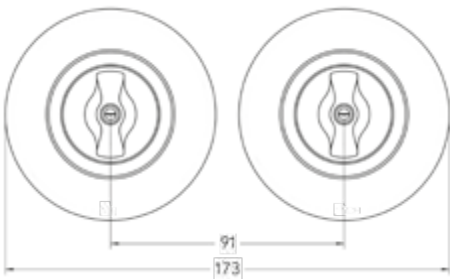

When assembling several units vertically or horizontally in single coverings, for optical reasons we recommend a spacing of 91 mm.

See and be seen – our references.

Our switches, lights and fittings have been installed in numerous buildings since our company was founded more than 25 years ago.

We present some of these objects on our homepage to give you a visual impression of how our products can look in a wide variety of living environments.

You will soon realise: Not only old buildings benefit from their classic design, but also any place that does not want to submit to the constantly changing design specifications of the fashion world.

If you would like to see one of your projects mentioned in our references, please do not hesitate to contact us.

www.thpg.com/en/references



Hotel Le Fleur
© Philipp Mayrhofer



Gemminger Hof
© Daniel Wieser Architekturfotografie



Haus Stutensee
© La Croix Architekten



Belfort
© arbr Architekten



1. System: Porcelain. Now also black glazed.

If our customers were already fixed on the colour black for their new switches, they had but little choice in material until recently: Bakelite was their only option. However, this has now changed. Our classic porcelain switch system is now also available in a black glaze. So you can choose as you wish and let your decision in favour of one of our switch systems be guided entirely by its specific materiality and discreet design.



Switch system Porcelain black.



Switch system Porcelain black



Rotary switch

10 A, 10 AX, AC 250 V. Porcelain central insert and handle. With spring mechanism.

Rotary switch alternation

Product code **174006**

Rotary switch cross

Product code **174007**

Rotary switch series

Product code **174008**

Rotary switch blind

Product code **174009**

Rotary switch two-pole

Product code **174010**



Toggle switch

10 A, 10 AX, AC 250 V. Porcelain central insert and Bakelite toggle.

Toggle switch alternation

Product code **174011**

Toggle switch cross

Product code **174012**

Rocker switch

10 A, 10 AX, AC 250 V. Porcelain central insert and Bakelite rocker.

Rocker switch alternation

Product code **174013**

Rocker switch cross

Product code **174014**

Rocker switch control

with glow lamp Product code **174016**



Rocker button

10 A, AC 250 V. Porcelain central insert and Bakelite rocker.

Rocker button

Product code **174016**

Rocker button luminescent

Product code **174017**



Rocker button light

10 A, AC 250 V. Porcelain central insert and Bakelite rocker with engraved light bulb symbol.

Rocker button light

Product code **174018**

Rocker button light luminescent

Product code **174019**

Glow lamp

The glow lamp is to be put in place of the lower screw.

Product code **174015**



Rocker button bell

10 A, AC 250 V. Porcelain central insert and Bakelite rocker with engraved bell symbol.

Rocker button bell

Product code **174020**

Rocker button bell luminescent

Product code **174021**



Rocker button door opener

10 A, AC 250 V. Porcelain central insert and Bakelite rocker with engraved key symbol.

Rocker button door opener

Product code **174022**

Rocker button door opener luminescent

Product code **174023**



Dimmer

AC 230 V, 50 Hz. Porcelain central insert and dimming knob.

Dimmer LED

3-35 W, 7-110 W/VA. Pressure alternation. Product code **174028**

Universal dimmer LED

3-80 W, 7-200 W/VA. Pressure alternation. Product code **174030**

Universal dimmer PRO LED

3-130 W, 7-350 W/VA. Pressure alternation. Product code **174029**



Temperature Control

230 V~/50 Hz. Use as room or floor thermostat. Bakelite central insert.

Product code **174032**

Clock Thermostat

230 V~/50 Hz. Use as a room or floor thermostat with an extended range of functions. Settings can be changed via a mini USB connection. Central insert made of Bakelite.

Product code **174031**

Remote sensor

For temperature control and clock thermostat. NTC remote sensor. Length 4 m. Length can be customized. Product code **174025**

Cover for sensor

Copper cover for our remote sensor. For installation in the floor. Ø 21 mm/8 mm, length 113 mm.

Product code **174026**



Outlet

16 A, AC 250 V. Bakelite central insert. With screw contacts.

Product code **174024**

Outlet with shutter

16 A, AC 250 V. Bakelite central insert with shutter. With screw contacts.

Product code **174025**



Outlet French version

16 A, AC 250 V. Bakelite central insert. With screw contacts.

French version. With shutter. Product code **174026**

Outlet Swiss version Type 13

10 A, AC 250 V. Bakelite central insert. With screw contacts. For installation in DIN 49073-certified units.

Product code **174027**



USB Charging Station

100-240 V~/50-60 Hz. Bakelite central insert. Max. charging 2,5 A in total. Two charging sockets USB Type A. Product code **174038**

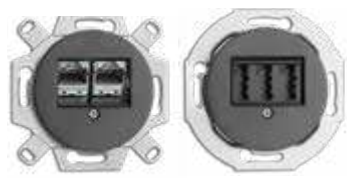

Data outlet

Bakelite central insert. For 2 network adapters RJ45 (real.Cat.6a).

Product code **174033**

Note: We recommend concealed sockets with increased socket volume for easy data outlet installation.

Telephone jack

Bakelite central insert. TAE 3 x 6 NFN. For 1 telephone and 2 additional devices or data terminals. 3 x 6-pin, 6 screw contacts.

Product code **174034**

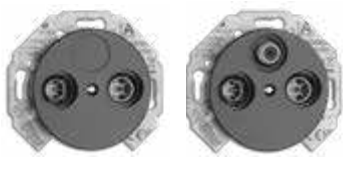

Antenna outlet cable

Bakelite central insert. HF-resistant metal housing. BZT-approved. Radio and television adapter for systems with amplifiers or cable. Passage and terminal box.

Product code **174035**

Antenna outlet satellite

Bakelite central insert. HF-resistant metal housing. BZT-approved. Radio and television adapter for systems with amplifiers. Compliant with DIN 45330 with additional satellite outlet. Product code **174036**



Speaker wall socket WBT

Bakelite central insert. Gold-plated connections from WBT.

Product code **174039**

Blind cover Porcelain

Bakelite central insert.

Product code **174037**



Junction boxes Keystones

Bakelite central insert. Technical information on the specific products can be found on our homepage. Further configurations possible, see p. 29.

SAT/Data outlet combined

Product code **174049**

Cinch connection red/white

Product code **174040**

Cinch connection yellow/black

Product code **174041**

USB-C 3.1. connection

Product code **174043**

HDMI connection

Product code **174044**

FO socket Simplex

Product code **174047**

FO socket Duplex

Product code **174048**

Universal cable outlet

Product code **174045**



Single covering

Ø 82 mm. Suitable for all switches, dimmers and outlets of the THPG switch system Porcelain.
Product code **173085**

Single covering for junction boxes

Ø 82 mm. Suitable for junction boxes, temperature controls, clock thermostat and USB charging station of the THPG switch system Porcelain.
Product code **173086**



System covering external

Ø 82 mm. For vertical or horizontal assembly. Suitable for all switches, dimmers and outlets of the THPG switch system Porcelain.
Product code **173088**

System covering for junction boxes external

Ø 82 mm. Suitable for junction boxes, temperature controls, clock thermostat and USB charging station of the THPG switch system Porcelain.
Product code **173089**



System covering centre

Ø 82 mm. For vertical or horizontal assembly. Suitable for all switches, dimmers and outlets of the THPG switch system Porcelain.
Product code **173087**



Double covering

External dimensions 82 x 153 mm. For vertical or horizontal assembly. Suitable for all switches, dimmers and outlets of the THPG switch system Porcelain.
Product code **173090**

Dimensions and assembly (in mm)

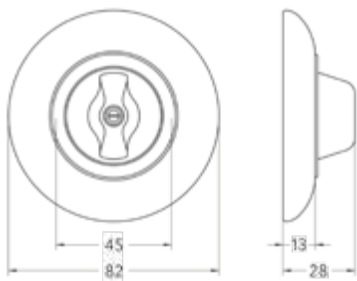

Single covering with rotary switch

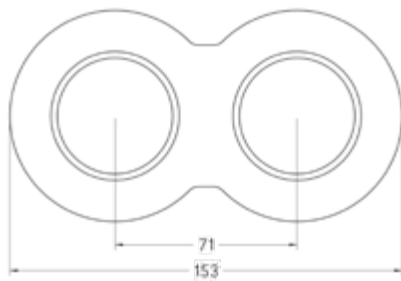

Double covering

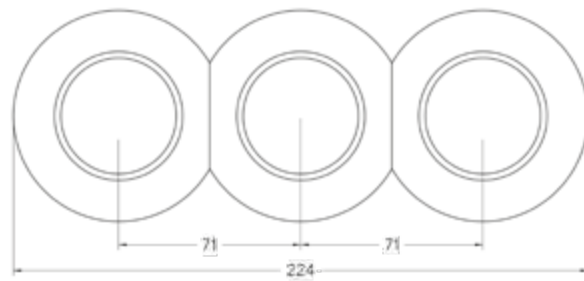

System covering with three covers

Assembly note: The spacing of the inserts in all multiple and system coverings correspond to the standard spacing of 71 mm and can be used in existing installations without any problems. The porcelain switch system of course fits into the commercially available, standardised flush-mounted boxes (e.g. from Kaiser).

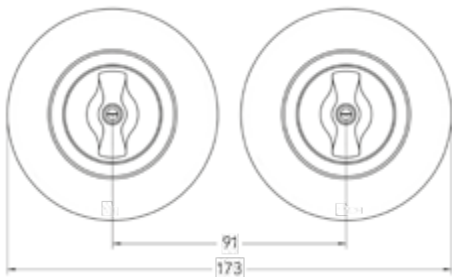

When assembling several units vertically or horizontally in single coverings, for optical reasons we recommend a spacing of 91 mm.

Technical information

Alternation switch

These switches can be either used individually as on/off switches or together with a second one to switch a lamp in alternation.

Cross switch

This switch becomes necessary for switching from more than two places.

Series switch

This switch can be used to switch two lamps. The lamps can be switched off separately or together.

Blind switch (group switch)

Switches like a series switch, but always separately. Ideal for switching roller shutter motors.

Rocker button

The rocker is held in position by a spring. Pressing the rocker closes the circuit. Doorbells and door openers work according to this principle. A rocker switch can also be used in combination with a relay. This allows the light in a stairwell, for example, to be switched off automatically after a preset time.

THPG rotary switch

A spring mechanism takes over the shifting process after a quarter turn of the handle.

Toggle/Rocker switch

Switching is done by pressing the rocker or using the toggle.

Outlet

In Germany and many other European countries a socket outlet with earthing contacts on the side is common.

Outlet with shutter

An integrated latch ("shutter") allows plugs to reach the contacts only if both openings are pushed into at the same time. A certain stiffness is intended.



VDE test mark

All our switches and outlets bear the VDE test mark, insofar as it is possible to issue the test.



Rotary switch Bakelite with double covering
Gut Manhagen, Langwedel
More images available at www.thpg.com/en/references
©THPG

2. System: Bakelite® and Duroplast: The durable predecessors of modern plastic.

In the first half of the 20th century, the name Bakelite was virtually synonymous with plastics. With the emergence of later thermoplastics, "Bakelite" has come to be used to describe the old heavy thermosets (melamine, phenolic resins) as distinct from other types that are somewhat disparagingly referred to merely as "plastic". Contrary to what one might expect from the common usage of the term, "Bakelite" is not a generic name. Instead, it is a trademark, and in the case of Germany it is registered to Bakelite GmbH, which is based in Iserlohn. This situation has created some confusion in terminology. Bakelite is a thermosetting polymer (a thermoset or duroplast, for short), but not every duroplast is Bakelite. Hence the distinction on our part: The black and white switch series are both made of thermosetting polymers, but only the black one is Bakelite in the trademarked sense, while the white one is moulded from a related resin.



Switch system Bakelite® with round covers.



Switch system Bakelite® with square covers.



Switch system Duroplast with round covers.



Switch system Duroplast with square covers.



Switch system Bakelite®



Rotary switch

10 A, 10 AX, AC 250 V. Bakelite central insert and handle. With spring mechanism.

Rotary switch alternation

Product code **186883**

Rotary switch cross

Product code **186884**

Rotary switch series

Product code **186882**

Rotary switch blind

Product code **186895**

Rotary switch two-pole

Product code **100374**



Toggle switch

10 A, 10 AX, AC 250 V. Bakelite central insert and toggle.

Toggle switch alternation

Product code **173043**

Toggle switch cross

Product code **173044**

Double toggle switch series

10 A, 10 AX, AC 250 V. Bakelite central insert and two toggles.

Product code **100571**



Rocker switch

10 A, 10 AX, AC 250 V. Bakelite central insert and rocker.

Rocker switch alternation

Product code **173112**

Rocker switch cross

Product code **173113**

Rocker switch control with glow lamp

Product code **173047**

Rocker button

10 A, AC 250 V. Bakelite central insert and rocker.

Product code **173054**

Rocker button luminescent

Product code **100973**



Rocker button light

10 A, AC 250 V. Bakelite central insert and rocker with engraved light bulb symbol.

Rocker button light

Product code **173055**

Rocker button light luminescent

Product code **100974**

Glow lamp

The glow lamp is to be placed in place of the lower screw.

Product code **173066**



Rocker button bell

10 A, AC 250 V. Bakelite central insert and rocker with engraved bell symbol.

Rocker button bell

Product code **173056**

Rocker button bell luminescent

Product code **100975**



Rocker button door opener

10 A, AC 250 V. Bakelite central insert and rocker with engraved key symbol.

Rocker button door opener

Product code **173057**

Rocker button door opener luminescent

Product code **100976**



Dimmer

AC 230 V, 50 Hz. Bakelite central insert and dimming knob.

Dimmer LED

3-35 W, 7-110 W/VA. Pressure alternation. Product code **100274**

Universal dimmer LED

3-80 W, 7-200 W/VA. Pressure alternation. Product code **100410**

Universal dimmer PRO LED

3-130 W, 7-350 W/VA. Pressure alternation. Product code **100409**



Temperature control

230 V~/50 Hz. Bakelite central insert. Use as room or floor thermostat. Product code **100418**

Clock thermostat

230 V~/50 Hz. Bakelite central insert. Use as a room or floor thermostat with an extended range of functions. Settings can be changed via a mini USB connection.

Product code **100417**

Remote sensor

For temperature control and clock thermostat. NTC remote sensor. Length 4 m. Length can be customized. Product code **100425**

Cover for sensor

Copper cover for our remote sensor. For installation in the floor. Ø 21 mm/8 mm, length 113 mm. Product code **100426**



Outlet

16 A, AC 250 V. Bakelite central insert. With screw contacts.

Product code **173038**

Outlet with Shutter

16 A, AC 250 V. Bakelite central insert with shutter. With screw contacts.

Product code **174527**



Outlet French version

16 A, AC 250 V. Bakelite central insert. With screw contacts. French version. With Shutter.

Product code **175833**

Outlet Swiss version Type 13

10 A, AC 250 V. Bakelite central insert. With screw contacts. For installation in DIN 49073-certified units.

Product code **100940**



USB Charging Station

100-240 V~/50-60 Hz. Bakelite central insert. Max. charging 2,5 A in total. Two charging sockets USB Type A. Product code **100876**

Speaker wall socket WBT

Bakelite central insert. Gold-plated connections from WBT.

Product code **100737**



Junction boxes Keystones

Bakelite central insert. Technical information on the specific products can be found on our homepage. Further configurations possible, see p. 29.

SAT/Data outlet combined

Product code **101369**

Cinch connection red/white

Product code **101360**

Cinch connection yellow/black

Product code **101361**

USB-C 3.1. connection

Product code **101363**

HDMI connection

Product code **101364**

FO socket simplex

Product code **101367**

FO socket duplex

Product code **101368**

Universal cable outlet

Product code **101365**



Data outlet

Bakelite central insert. For 2 network adapters RJ45 (real.Cat.6a).

Product code **100722**

Note: We recommend concealed sockets with increased socket volume for easy data outlet installation.

Telephone jack

Bakelite central insert. TAE 3 x 6 NFN. for 1 telephone and 2 additional devices or data terminals.

Product code **100721**



Antenna outlet cable

Bakelite central insert. HF-resistant metal housing. BZT-approved. Radio and television adapter for systems with amplifiers or cable. Passage and terminal box.

Product code **100723**

Antenna outlet satellite

Bakelite central insert. HF-resistant metal housing. BZT-approved. Radio and television adapter for systems with amplifiers. Compliant with DIN 45330 with additional satellite outlet (F-adapter). Terminal box. Digitally compatible.

Product code **100724**



Blind cover

Bakelite central insert.

Product code **173115**

Pull switch

10 A, 10 AX, AC 250 V. Bakelite central insert and pull switch insert.

Product code **173114**



Single covering round

Ø 82 mm. Suitable for all switches and outlets of the THPG switch system Bakelite.

Product code **173063**



System covering external

Ø 82 mm. For vertical or horizontal assembly. Suitable for all switches and outlets of the THPG switch system Bakelite.

Product code **173092**



System covering centre

Ø 82 mm. For vertical or horizontal assembly. Suitable for all switches and outlets of the THPG switch system Bakelite.

Product code **173093**



Single covering square

82 x 82 mm. Suitable for all switches, rocker switches and outlets of the THPG switch system Bakelite.

Product code **119328**

Single covering for junction boxes/dimmers round

Ø 82 mm. Suitable for junction boxes, dimmers, temperature controls, clock thermostat and USB charging station of THPG switch system Bakelite.

Product code **174940**

System covering for junction boxes/dimmers external

Ø 82 mm. Suitable for junction boxes, dimmers, temperature controls, clock thermostat and USB charging station of THPG switch system Bakelite.

Product code **173094**

System covering for junction boxes/dimmers centre

Ø 82 mm. Suitable for junction boxes, dimmers, temperature controls, clock thermostat and USB charging station of THPG switch system Bakelite.

Product code **173095**

Single covering for junction boxes/dimmers square

82 x 82 mm. For assembling dimmers, data sockets, telephone and antenna outlets, speaker wall socket, temperature controls, clock thermostat and USB charging point.

Product code **119327**



Double covering

External dimensions 82 x 157 mm. For vertical or horizontal assembly. Suitable for all inserts of the THPG switch system Bakelite.

Product code **173064**



Quadruple covering

External dimensions 299 x 82 mm. For vertical or horizontal assembly. Suitable for all inserts of the THPG switch system Bakelite.

Product code **173091**

Triple covering

External dimensions 82 x 228 mm. For vertical or horizontal assembly. Suitable for all inserts of the THPG switch system Bakelite.

Product code **173065**

Dimensions and assembly (in mm)

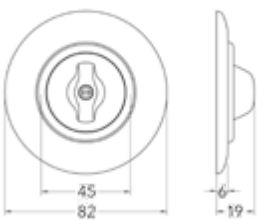

Single covering round with rotary switch

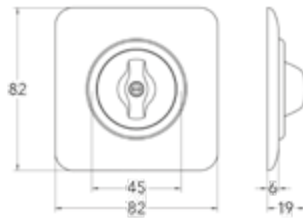

Single covering square with rotary switch

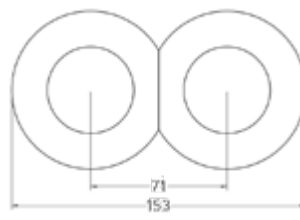

System covering with two covers

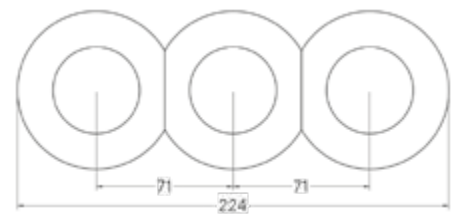

System covering with three covers



Double covering

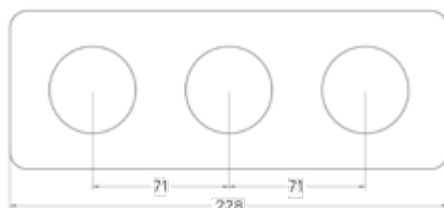

Triple covering

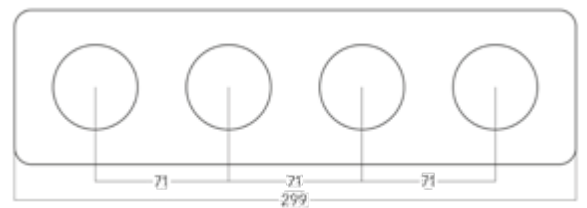

Quadruple covering

Assembly note: The spacing of the inserts in all multiple and system coverings correspond to the standard spacing of 71 mm and can be used in existing installations without any problems. The Bakelite switch system of course fits into the commercially available, standardised flush-mounted boxes (e.g. from Kaiser).

When assembling several units vertically or horizontally in single coverings, for optical reasons we recommend a spacing of 91 mm.

Switch system Duroplast



Rotary switch

10 A, 10 AX, AC 250 V. Duroplast central insert and handle. With spring mechanism.

Rotary switch alternation

Product code **186886**

Rotary switch cross

Product code **186887**

Rotary switch series

Product code **186885**

Rotary switch blind

Product code **186896**

Rotary switch two-pole

Product code **100382**



Toggle switch

10 A, 10 AX, AC 250 V. Duroplast central insert and toggle.

Toggle switch alternation

Product code **176405**

Toggle switch cross

Product code **176406**

Double toggle switch series

10 A, 10 AX, AC 250 V. Duroplast central insert and two toggles.

Product code **100572**



Rocker switch

10 A, 10 AX, AC 250 V. Duroplast central insert and rocker.

Rocker switch alternation

Product code **176429**

Rocker switch cross

Product code **176430**

Rocker switch control

With glow lamp.

Product code **176407**

Rocker button

10 A, AC 250 V. Duroplast central insert and rocker.

Product code **176408**

Rocker button luminescent

Product code **100981**



Rocker button light

10 A, AC 250 V. Duroplast central insert and rocker with engraved light bulb symbol.

Rocker button light

Product code **176409**

Rocker button light luminescent

Product code **100982**

Glow lamp

The glow lamp is to be placed in place of the lower screw.

Product code **173066**



Rocker button bell

10 A, AC 250 V. Duroplast central insert and rocker with engraved bell symbol.

Rocker button bell

Product code **176410**

Rocker button bell luminescent

Product code **100983**



Rocker button door opener

10 A, AC 250 V. Duroplast central insert and rocker with engraved key symbol.

Rocker button door opener

Product code **176411**

Rocker button door opener luminescent

Product code **100984**



Dimmer

AC 230 V, 50 Hz. Duroplast central insert and dimming knob.

Dimmer LED

3-35 W, 7-110 W/VA. Pressure alternation. Product code **100308**

Universal dimmer LED

3-80 W, 7-200 W/VA. Pressure alternation. Product code **100412**

Universal dimmer PRO LED

3-160 W, 7-350 W/VA. Pressure alternation. Product code **100411**



Temperature control

230 V~/50 Hz. Duroplast central insert. Use as room or floor thermostat. Product code **100420**

Clock thermostat

230 V~/50 Hz. Duroplast central insert. Use as a room or floor thermostat with an extended range of functions. Settings can be changed via a mini USB connection. Product code **100419**

Remote sensor

For temperature control and clock thermostat. NTC remote sensor. Length 4 m. Length can be customized. Product code **100425**

Cover for sensor

Copper cover for our remote sensor. For installation in the floor. Ø 21 mm/8 mm, Length 113 mm. Product code **100426**



Outlet

16 A, AC 250 V. Duroplast central insert. With screw contacts.

Product code **176400**

Outlet with Shutter

16 A, AC 250 V. Duroplast central insert with shutter. With screw contacts. Product code **180810**



Outlet French version

16 A, AC 250 V. Duroplast central insert. With screw contacts. French version. With Shutter. Product code **184728**

Outlet Swiss version Type 13

10 A, AC 250 V. Duroplast central insert. With screw contacts. For installation in DIN 49073-certified installation units. Product code **100969**



USB Charging Station

100-240 V~/50-60 Hz. Duroplast central insert. Max. charging 2,5 A in total. Two charging sockets USB Type A. Product code **100877**

Speaker wall socket WBT

Bakelite central insert. Gold-plated connections from WBT. Product code **100739**



Junction boxes Keystones

Duroplast central insert. Technical information on the specific products can be found on our homepage. Further configurations possible, see p. 29.

SAT/Data outlet combined

Product code **101359**

Cinch connection red/white

Product code **101350**

Cinch connection yellow/black

Product code **101351**

USB-C 3.1. connection

Product code **101353**

HDMI connection

Product code **101354**

FO socket simplex

Product code **101357**

FO socket duplex

Product code **101358**

Universal cable outlet

Product code **101355**



Data outlet

Duroplast central insert. For 2 network adapters RJ45 (real.Cat.6a). Product code **100726**

Note: We recommend concealed sockets with increased socket volume for easy data outlet installation.

Telephone jack

Duroplast central insert. TAE 3 x 6 NFN. for 1 telephone and 2 additional devices or data terminals. 6 screw contacts. Product code **100725**



Antenna outlet cable

Duroplast central insert. HF-resistant metal housing. BZT-approved. Radio and television adapter for systems with amplifiers or cable. Passage and terminal box. Product code **100727**

Antenna outlet satellite

Duroplast central insert. HF-resistant metal housing. BZT-approved. Radio and television adapter for systems with amplifiers. Compliant with DIN 45330 with additional satellite outlet (F-adapter). Terminal box. Digitally compatible. Product code **100728**



Pull switch

10 A, 10 AX, AC 250 V. Duroplast central insert and pull switch insert. Product code **176431**

Blind cover

Duroplast central insert. Product code **176432**



Single covering round
 Ø 82 mm. Suitable for all switches, rocker switches and outlets of the THPG switch system Duroplast.
 Product code **176421**



System covering external
 Ø 82 mm. For vertical or horizontal assembly. Suitable for all switches, rocker switches, and outlets of the THPG switch system Duroplast.
 Product code **176425**



System covering centre
 Ø 82 mm. For vertical or horizontal assembly. Suitable for all switches and outlets of the THPG switch system Duroplast.
 Product code **176426**



Single covering square
 82 x 82 mm. Suitable for all switches and outlets of the THPG switch system Duroplast.
 Product code **119330**

Single covering for junction boxes/dimmers round

Ø 82 mm. Suitable for junction boxes, dimmers, temperature controls, clock thermostat and USB charging station of THPG switch system Duroplast.
 Product code **181997**

System covering for junction boxes/dimmers external

Ø 82 mm. Suitable for junction boxes, dimmers, temperature controls, clock thermostat and USB charging station of THPG switch system Duroplast.
 Product code **176427**

System covering for junction boxes/dimmers centre

Ø 82 mm. Suitable for junction boxes, dimmers, temperature controls, clock thermostat and USB charging station of THPG switch system Duroplast.
 Product code **176428**

Single covering for junction boxes/dimmers square

82 x 82 mm. For assembling dimmers, data sockets, telephone and antenna outlets, speaker wall socket, temperature controls, clock thermostat and USB charging point.
 Product code **119329**



Double covering
 External dimensions 82 x 157 mm. For vertical or horizontal assembly. Suitable for all inserts of the THPG switch system Duroplast.
 Product code **176422**

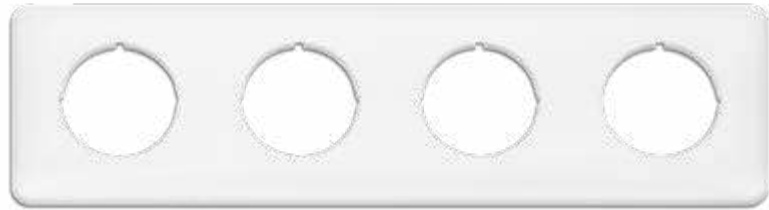

Quadruple covering
 External dimensions 299 x 82 mm. For vertical or horizontal assembly. Suitable for all inserts of the THPG switch system Duroplast.
 Product code **176424**

Triple covering
 External dimensions 82 x 228 mm. For vertical or horizontal assembly. Suitable for all inserts of the THPG switch system Duroplast.
 Product code **176423**

Dimensions and assembly (in mm)

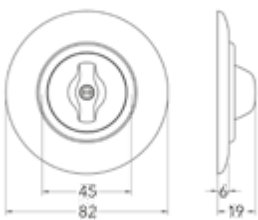

Single covering round with rotary switch

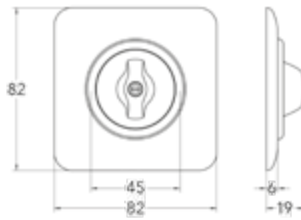

Single covering square with rotary switch

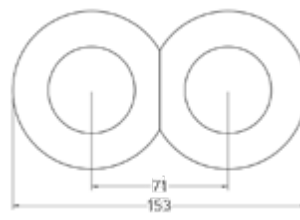

System covering with two covers

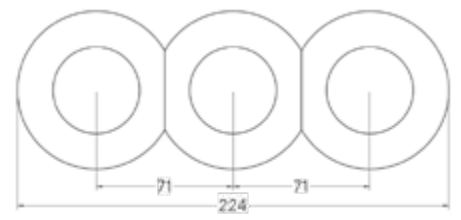

System covering with three covers

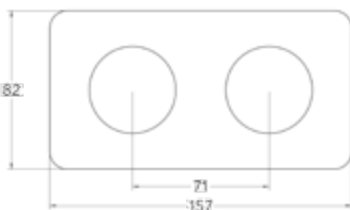

Double covering

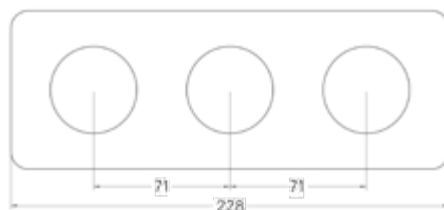

Triple covering

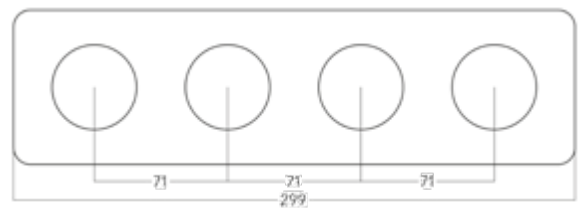

Quadruple covering

Assembly note: The spacing of the inserts in all multiple and system coverings correspond to the standard spacing of 71 mm and can be used in existing installations without any problems. The Duroplast switch system of course fits into the commercially available, standardised flush-mounted boxes (e.g. from Kaiser).

When assembling several units vertically or horizontally in single coverings, for optical reasons we recommend a spacing of 91 mm.



Rotary switch and outlet Bakelite®
with external system covering polished glass.
Example of application
©THPG

3. System: It can also be more discreet. With coverings made of polished glass.

In this system, the central inserts are covered by nearly neutral-coloured special glass with edges that practically vanish in a highly polished 45° facet cut. This reduces the rugged physical presence of Bakelite/Duroplast switches, an effect that is further reinforced if the wallpaper is placed below the glass covering. You can combine the glass coverings with all kinds of switches and outlets from our switch systems Bakelite® and Duroplast. This system also includes coverings that make it possible to place the switches above or next to each other, but does not involve multiple coverings. All of our glass parts come from one of what were formerly many glassworks in the Upper Palatine Forest. The glass panes are 4 mm thick and thermally tempered. They offer superior transparency.



Switch system white glass with Bakelite®.



Switch system white glass with Duroplast.



White glass



Single covering
 Ø 82 mm. Compatible with all inserts of the THPG switch systems Bakelite and Duroplast.
 Product code **100609**



System covering centre
 Ø 82 mm. For vertical or horizontal assembly. Compatible with all inserts of the THPG switch systems Bakelite and Duroplast.
 Product code **100611**



System covering external
 Ø 82 mm. For vertical or horizontal assembly. Compatible with all inserts of the THPG switch systems Bakelite and Duroplast.
 Product code **100613**



Combine as you wish

The three coverings on the left are compatible with all central inserts of the switch systems Bakelite and Duroplast.

Dimensions and assembly (in mm)

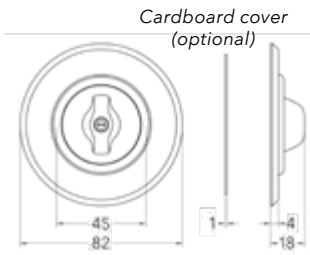

Single covering for central inserts with rotary switch

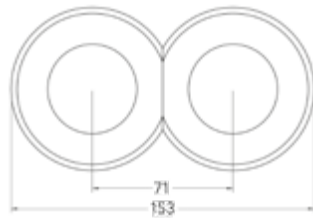

System covering for central inserts with two covers

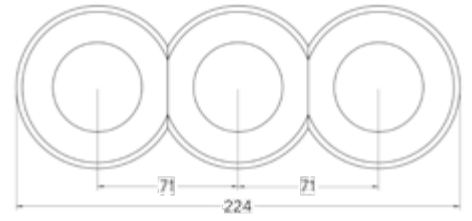

System covering for central inserts with three covers



Single covering full-surface
 Ø 82 mm. For assembly of rotary switch white glass
 Product code **100608**



System covering centre full-surface
 Ø 82 mm. For vertical or horizontal assembly of rotary switch white glass.
 Product code **100610**



System covering external full-surface
 Ø 82 mm. For vertical or horizontal assembly of rotary switch white glass.
 Product code **100612**

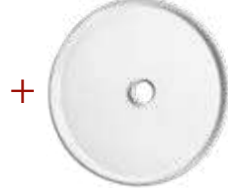

Combine as you wish

The three full-surface coverings are only compatible with the white glass rotary switches, but can be combined with the other white glass system coverings. Examples of combinations with Bakelite and Duroplast can be found on page 22.

Dimensions and assembly (in mm)

Cardboard cover (optional)

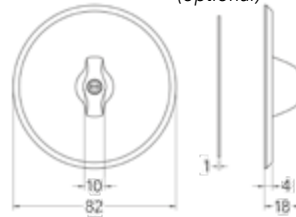

Single covering full-surface with rotary switch white glass

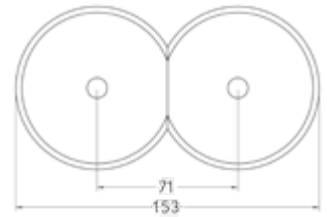

System covering full-surface with two covers

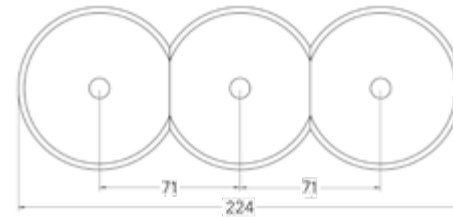

System covering full-surface with three covers



Rotary switch white glass Bakelite
 10 A, 10 AX, AC 250 V. Without central insert. Bakelite handle. With spring mechanism.

Rotary switch alternation
 Product code **100641**

Rotary switch cross
 Product code **100642**

Rotary switch series
 Product code **100643**

Rotary switch blind
 Product code **100644**



Rotary switch white glass Duroplast
 10 A, 10 AX, AC 250 V. Without central insert. Duroplast handle. With spring mechanism.

Rotary switch alternation
 Product code **100666**

Rotary switch cross
 Product code **100667**

Rotary switch series
 Product code **100668**

Rotary switch blind
 Product code **100669**

When assembling several units vertically or horizontally in single coverings, for optical reasons we recommend a spacing of 91 mm.

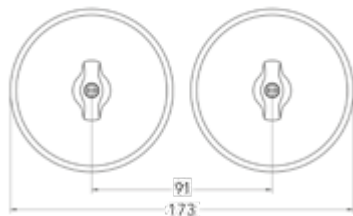

Assembly note: The spacing of the inserts in all system coverings correspond to the standard spacing of 71 mm and can be used in existing installations without any problems. The white glass switch system of course fits into the commercially available, standardised flush-mounted boxes (e.g. from Kaiser).



Rotary switch surface-mounted Duroplast
Ernst-May-Haus, Frankfurt
<https://ernst-may-gesellschaft.de/mayhaus/musterhaus>

4. System: Uncomplicated, robust, economical: Surface-mounted switches made of Bakelite® and Duroplast.

Surface-mounted installation of electrical cables and switches is always the best option when economic, structural and pragmatic aspects take centre stage. Two small drill holes are all you need for a secure fit - there's no need for tedious slotting and chiselling of walls. Inspection, repair and expansion of the systems are possible at any time without any problems. The housings are moulded in one piece from 2.5 mm thick material.

Knock-outs at the sides allow cable entry. These switches are solidly built inside and out and are designed for a long, trouble-free service life. A thoroughly pragmatic solution with a classic look.



Switch system surface-mounted Bakelite®



Rotary switch

10 A, 10 AX, AC 250 V, IP20.
Housing and handle made of Bakelite. With spring mechanism.

Rotary switch alternation

Product code **186892**

Rotary switch cross

Product code **186893**

Rotary switch series

Product code **186891**



Toggle switch

10 A, 10 AX, 250 V, IP20.
Housing and toggle made of Bakelite.

Toggle switch alternation

Product code **184198**

Toggle switch cross

Product code **184207**



Outlet

16 A, AC 250 V, IP20.
Housing made of Bakelite. With shutter. With screw contacts.

Product code **184200**

Outlet French version

16 A, AC 250 V, IP 20. Housing made of Bakelite. With shutter and screw contacts.

Product code **100063**



Outlet Swiss version

Type 13
16 A, AC 250 V, IP 20. Housing made of Bakelite. With screw contacts.

Product code **101118**

Pull switch

10A, 10 AX, AC 250 V. Housing and pull switch insert made of Bakelite.

Product code **184209**

Base plate

Made of Bakelite. Required for assembly on flammable ground and recommended for uneven surfaces.



Product code **184619**

Switch system surface-mounted Duroplast



Rotary switch

10 A, 10 AX, AC 250 V, IP20.
Housing and handle made of Duroplast. With spring mechanism.

Rotary switch alternation

Product code **186889**

Rotary switch cross

Product code **186890**

Rotary switch series

Product code **186888**



Toggle switch

10 A, 10 AX, 250 V, IP20.
Housing and toggle made of Duroplast.

Toggle switch alternation

Product code **184197**

Toggle switch cross

Product code **184206**



Outlet

16 A, AC 250 V, IP20.
Housing made of Duroplast. With shutter. With screw contacts.

Product code **184199**

Outlet French version

16 A, AC 250 V, IP 20. Housing made of Duroplast. With shutter and screw contacts.

Product code **100062**



Outlet Swiss version

Type 13
16 A, AC 250 V, IP 20. Housing made of Duroplast. With screw contacts.

Product code **101117**

Pull switch

10A, 10 AX, AC 250 V. Housing and pull switch insert made of Duroplast.

Product code **184210**

Base plate

Made of Duroplast. Required for assembly on flammable ground and recommended for uneven surfaces.



Product code **184642**

Dimensions and assembly (in mm)

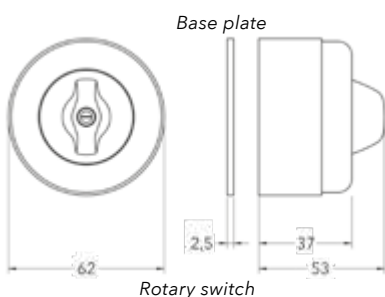

Rotary switch

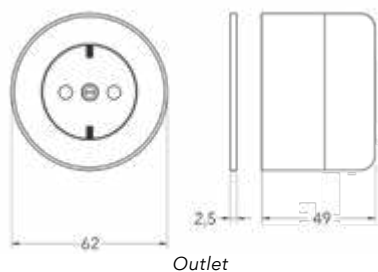

Outlet

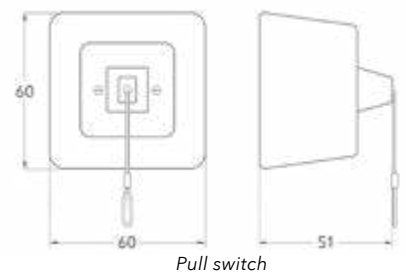

Pull switch



Rotary switch alternation moisture-proof Bakelite
Head office of the Hoofsche Stiftung Bodenständigkeit,
Lüdinghausen.
© THPG

5. System: The tough ones. For humid environments and outdoor use. Moisture-proof Bakelite® switches. IP44.

They are a piece of electrical industry history. From the late 19th well into the mid-20th century, they could be found in industrial settings and the basements of private homes, bearing the famous names of Siemens-Schuckert and Dr. Deisting. They were among the technical equipment that inspired deep trust in its functionality because of its sturdy physical appearance alone.

And they truly deserve that trust. Electricians today are still amazed at how well even very old installations work, both electrically and mechanically. This is one of the reasons we decided against reinventing these switches and outlets. They remain just as they were: crafted from 2.5 mm thick Bakelite, with a switching mechanism that underscores its authenticity also acoustically.



Dimensions and assembly (in mm)

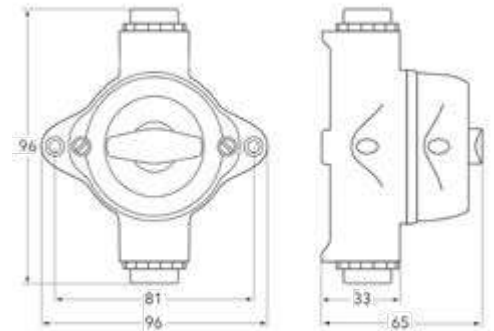

Rotary switch alternation moisture-proof passage

Rotary switch alternation moisture-proof
10 A, 10 AX, AC 250 V, IP44. 96 x 85 mm. Height above plaster 70 mm. Two-part case and handle made of Bakelite with a single input.

Product code **100831**

Rotary switch cross moisture-proof

Product code **100959**

Rotary switch alternation moisture-proof passage

10 A, AC 250 V, IP44. 96 x 116 mm. Height above plaster 70 mm. For vertical combination of outlet and rotary switch. Classically, the rotary switch is placed above the outlet. Two-part case and handle made of Bakelite with opposite input and output.

Product code **100832**

IP44: Protected against foreign objects > 1 mm. Protected against splash water from all sides.



Outlet double input moisture-proof
16 A, AC 250 V, IP44. 96 x 85 mm. Height above plaster 70 mm. Two-part case and lid made of Bakelite with adjacent input and output. With integrated shutter. With screw contacts. IP44 with sealed lid, IP20 with plug inserted.

Product code **100830**

Outlet double input moisture-proof French version
Product code **100939**

Outlet passage moisture-proof
16 A, AC 250 V, IP44. 96 x 116 mm. Height above plaster 70 mm. Two-part case and lid made of Bakelite with input and output on opposite sides. With integrated shutter. With screw contacts. IP44 with sealed lid, IP20 with plug inserted.

Product code **100829**

Outlet passage moisture-proof French version
Product code **100938**

Outlet moisture-proof
16 A, AC 250 V, IP44. 96 x 85 mm. Height above plaster 70 mm. Two-part case and lid made of Bakelite with a single input. With integrated shutter. With screw contacts. IP44 with sealed lid, IP20 with plug inserted.

Product code **100828**

Outlet moisture-proof French version
Product code **100937**

Accessories: Connect, extend, distribute.

Textile cables for laying on plaster. Black.

In addition to its economic appeal, surface-mounted installation also has an aesthetic appeal, for example in factory rooms and basements that have been converted into living quarters.

There, however, a major obstacle is in the way - the ugliness of today's standardised surface-mounted cables, which can least of all be reduced by concealing them in plastic cable ducts that look even more horrible. We have solved this problem:

Our cables are standardised and halogen-free NHXMH cables (5 x 1.5 mm² and 5 x 2.5 mm²). They are sheathed with standardised flame-retardant fabric by the last remaining German manufacturer of textile cables (Vogtländisches Kabelwerk GmbH). They are suitable for both indoor and outdoor use.



Surface-mounted textile cables

Textile-sheathed, halogen-free NHXMH cable. Suitable for both indoors and outdoors. Flame-retardant. We offer the cable in any length.

5 x 1.5 mm²

Product code **100834**

5 x 2.5 mm²

Product code **100294**



Matching cable clamps made of black plastic are also available. For fixing and steering the cable along the wall.

Cable clamps

For cables with 10-17 mm diameter. Length 35 mm, width 15 mm, height 24 mm, weight 10 g.

5 piece

Product code **100825**

20 piece

Product code **100826**

Junction box.

Fortunately, we were able to find the tool for this model, which must be more than 60 years old. After undergoing restoration and appropriate VDE-testing, this junction box now fills a gap in our surface-mounted range. Bakelite® housing in black or Duroplast housing in white with six knockout entries featuring rubber gaskets for various installation options.

Junction box surface-mounted

AC 400 V. For cables up to 4 x 2.5 mm². 95 x 95 x 45 mm. Weight 140 g. IP44.

Bakelite Product code **100922**

Duroplast Product code **100923**



For special applications.

Garage outlet: Prevents sparking. Produced in Germany.

The special feature: Power can only be drawn when the socket is locked (switch position I). Position 0 releases the plug again, which also de-energises the socket. Originally for use in safety-relevant areas such as boiler rooms, construction sites and, as the name suggests, garages, where a spark could cause an explosion if the plug is pulled out. Installation and cable feed are surface-mounted.

Garage outlet surface-mounted

Two-pole. 16 A, AC 250 V, IP20.
Case and lid made of Bakelite®.
With screw contacts.

Product code **100295**



Dimensions and assembly (in mm)

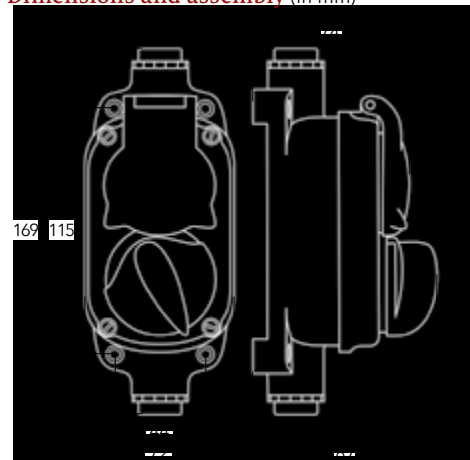

NEW: Configurable junction boxes.

We have added a range of technical connections to each of our switch systems: from USB-C, CINCH and HDMI to fibre optic (FO) and SAT. The central inserts have the usual shape and are each equipped with up to two connections, so-called "keystones". In addition to the combinations shown, you can also put together your own connections. If you only need one keystone, the hole for the second one is closed with a dummy plug. For an extra charge, we also offer a special support frame in which a single keystone can be placed in the centre (last picture in the row). The universal cable outlet is ideal for applications that are not covered by the connections offered here. We will be happy to help you with any questions and with the selection of the right connections for you.



Sockets in signal colour.

Sockets in signal red can be used, for example, to identify sockets with an uninterruptible power supply (UPS) or an emergency or mains power supply.



Outlet Duroplast signal red

16 A, AC 250 V. Duroplast central insert.
With screw contacts.

Product code **178000**

Single covering round Duroplast signal red

Ø 82 mm. Suitable for all switches, rocker switches and outlets of the switch system Duroplast.

Product code **178024**

Single covering square Duroplast signal red

82 x 82 mm. Suitable for all switches and outlets of the THPG switch system Duroplast.

Product code **178026**

Other special applications? Please contact us.

We can also put together other connections and switches for you on request. Whether push-buttons as normally closed contacts that briefly interrupt a closed circuit, two-pole rotary switches that can de-energise individual areas in a house distribution

board, or connections for DisplayPort and antenna distributors - thanks to our own production and a strong network of highly specialised partners (such as Rutenbeck), we can meet almost any requirement. Just get in touch with us.

+49 2591 2590-210 · info@thpg.de

The sound of bells instead of electronic whining.



A Bakelite® housing that contains an electric ringing mechanism from the 1960s: our doorbells. With flat or cone ringer. These melodious items should not be connected to a power line, but to a bell wire with an upstream transformer (output voltage 8-12 V~).



Flat ringer doorbell in Bakelite housing

Flat bell made of nickel-plated steel.
Volume 84 dB (A), 70 x 150 x 35 mm.
Weight 200 g. Product code **179983**



Cone ringer doorbell in Bakelite housing

Cone bell made of nickel-plated steel.
Volume 87 dB (A), 70 x 150 x 85 mm.
Weight 260 g. Product code **175074**

Our doorbell buttons.



Doorbell Bakelite black

Made of black Bakelite with black push-button (extra-low voltage push-button) with self-cleaning friction contact. Ø 50 mm, height 20 mm.
Max. 24 V~ (5 mA-1.5 A/24 VA)/max. 24 V= (5 mA-1.0 A/12 W).

Product code **100880**



Doorbell Bakelite black with white button

Made of black Bakelite with white push-button (extra-low voltage push-button) with self-cleaning friction contact. Ø 50 mm, height 20 mm.
Max. 24 V~ (5 mA-1.5 A/24 VA)/max. 24 V= (5 mA-1.0 A/12 W).

Product code **100881**



Doorbell Duroplast with black button

Made of white Duroplast with black push-button (extra-low voltage push-button) with self-cleaning friction contact. Ø 50 mm, height 20 mm.
Max. 24 V~ (5 mA-1.5 A/24 VA)/max. 24 V= (5 mA-1.0 A/12 W).

Product code **101013**



Doorbell Duroplast with white button

Made of white Duroplast with black push-button (extra-low voltage push-button) with self-cleaning friction contact. Ø 50 mm, height 20 mm.
Max. 24 V~ (5 mA-1.5 A/24 VA)/max. 24 V= (5 mA-1.0 A/12 W).

Product code **101441**

Where to buy

Our switch systems are available from our domestic and foreign retail partners, your local electrician, electrical wholesalers or directly from us. You can point your electrician, whom we strongly recommend for work on electrical installations, directly to us and we will coordinate delivery to you with him.

We can also give you the name of an electrician in your area who has worked with our products in the past.

You can call us Mondays to Thursdays during office hours from 8 a.m. to 5 p.m. and Fridays from 8 a.m. to 3 p.m. at +49 2591 2590-210. Or visit us online at www.thpg.de

Who we are.

The company THPG, established by Manufactum founder Thomas Hoof, was part of the Manufactum Group from 1998 to 2007, where it was responsible for the development and manufacture of Manufactum's own product lines. Today, it concentrates on the production and distribution of switch and lighting systems made of Bakelite®, porcelain and glass, which are now successful throughout Europe. They are most often used in the preservation of historical monuments, in the renovation of old buildings, in hotels, museums, commercial, public and private new buildings. Everywhere they appear, they are also a statement on distancing from trends and on durability as a virtue.



Since 2017, the company headquarters are located in Lüdinghausen, Germany.

What we stand for.

Quality.

Made in Germany and Europe.

What we do not produce ourselves in our own workshop in Lüdinghausen, we have manufactured for us by long-standing partners. The majority of these partners are based in Germany: in Westphalia, Franconia, the Rhine-Main region, Kraichgau and Vogtland - but also in Lower Silesia in Poland, Piedmont and Veneto in Italy.



Longevity.

Solid products made of Bakelite, glass and porcelain.

We work with traditional materials. Not just because

they are visually more pleasing. They all have convincing application-specific advantages and guarantee the long service life of our products.

Constructive transparency.

Comprehensible design, easy to dismantle.

Wherever possible, we design our switches, lights and fittings so that every component connection can be detached again and again. In concrete terms, this means screws instead of rivets and glue. This principle, once universally applied but now lost in the world of consumer goods, ensures that our products can be repaired and maintained.



Repairability.

Spare parts from our warehouse at all times.

We guarantee long product cycles. You can obtain spare and wear parts directly from our warehouse in a short space of time - and for many years to come. And if you don't want to do it yourself, we can do it for you. We repair at any time in our workshop.

Fashion distance.

Subtle shapes that you won't get tired of.

We offer products that will still look good even after many years: The timeless shape is not arbitrarily imposed on the object according to changing tastes, but follows its function. Fashion-related changes become obsolete.





Thomas Hoof Produktgesellschaft mbH & Co. KG
Bahnhofstr. 3 · D-59348 Lüdinghausen · Tel. +49 2591 2590-210
info@thpg.de

www.thpg.de